



Nordhydraulic
HYDAC INTERNATIONAL



Directional control valve RS 210



Solutions that power your visions

31-02-R210-07

Nordhydraulic AB

P.O Box 189 (Industrivägen 15)
SE-872 24 KRAMFORS
Sweden

Telephone: Int. +46 612 71 72 00
Telefax: Int. +46 612 71 72 15

E-mail: info@nordhydraulic.se
Web: www.nordhydraulic.se

Data sheet
Directional control valve / RS 210

Make use of the Nordhydraulic expertise

Our skilled and experienced design and application engineers are at your disposal, helping you to specify the valve configuration that meets your application requirements.

Key valve features

RS 210 is a sectional valve, designed for system pressures up to 350 bar and pump flows up to 70 l/min.

It is available with 1 to 10 working sections per valve assembly.

The valve can be used in different systems for parallel as well as tandem circuits. It is designed with an open centre for fixed and variable displacement pumps.

The valve can be operated manually, with cable or by pneumatic and electro-pneumatic remote control.

The valve offers excellent operating characteristics because of the specially designed spools for different applications.

Low and uniform spool forces are the result of careful balancing of the flow forces.

Q-function

The flow control (Q-function) of the inlet section bypasses the major part of the pump flow to tank when the system is idling, thereby greatly reducing heat generation. But it also gives access to the full pump flow when the services are operated and provide improved operating characteristics.

Applications

The RS 210 is ideal for applications where you need excellent control characteristics such as cranes, excavators, back-hoe-loaders, skid loaders and tipping gear.

Further RS 210 properties and possibilities

- Several different in- and outlet alternatives offering possibility for electrical unloading, connecting and dimensional flexibility.
- Very wide programme of different spools optimised for various pump flows, applications, system alternatives etc.
- Spool controls for external kick-out and spool position sensing.
- Load checks in each working section.
- High pressure carry-over.
- Left hand and right hand side inlet.



Data sheet

This data sheet presents a selection of standard components and how to specify these in a valve assembly according to your application requirements. For further information on RS 210 and available components, please contact Nordhydraulic.



Table of contents

<i>Technical data, weight</i>	<i>page</i>	4
<i>Inlet sections</i>	<i>page</i>	5 - 10
<i>Working sections</i>	<i>page</i>	11
<i>Intermediate/outlet sections</i>	<i>page</i>	12
<i>Electrical unloading valve</i>	<i>page</i>	13
<i>Main relief valves</i>	<i>page</i>	14 - 15
<i>Spools</i>	<i>page</i>	16
<i>Spool controls</i>	<i>page</i>	17
<i>Service port valves</i>	<i>page</i>	18
<i>Hydraulic diagram</i>	<i>page</i>	19

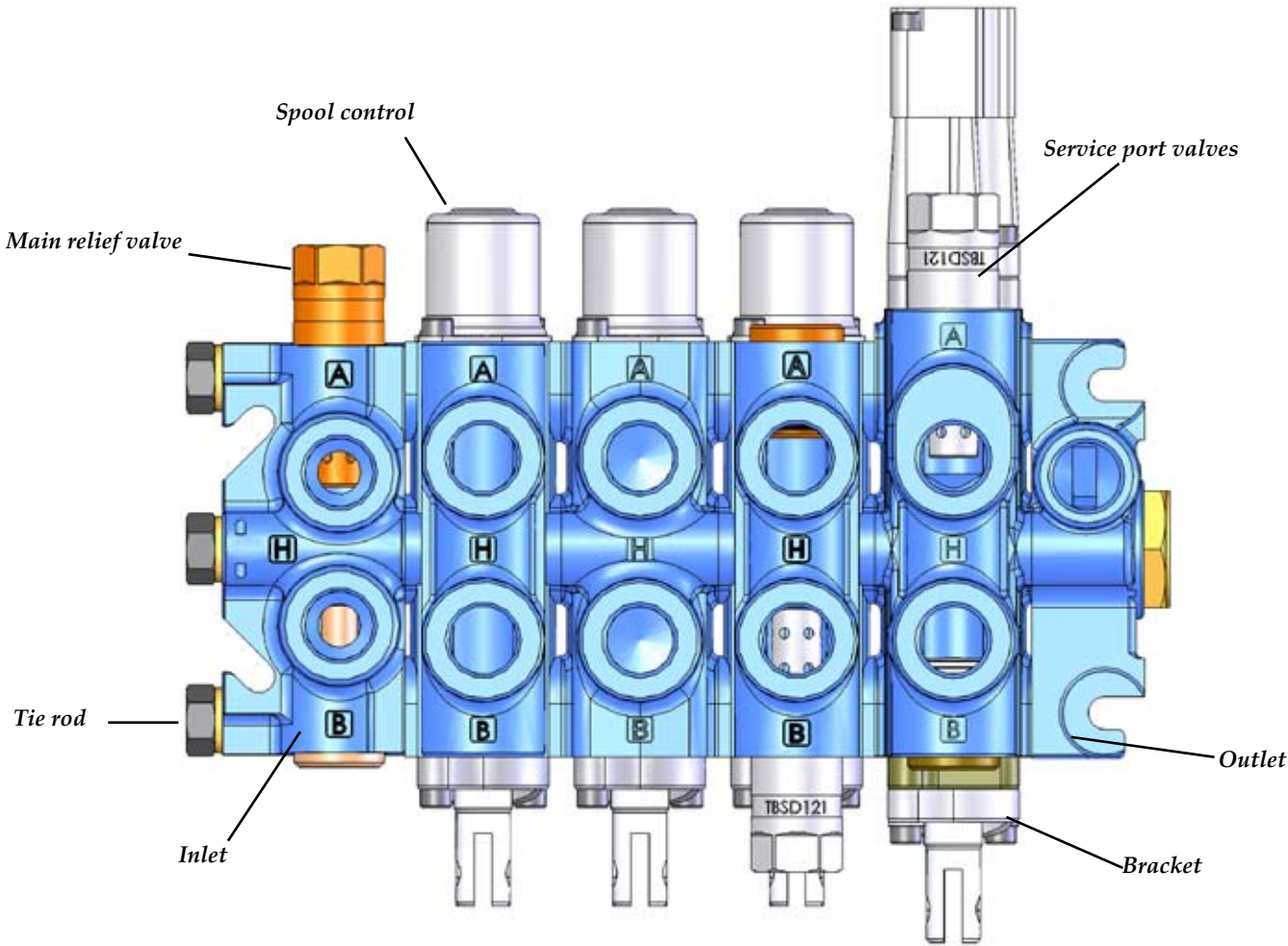

Technical data - weight - dimensions

Pressures / flow

Max. system pressure* 350 bar (35,0 MPa)
 Max continuous return line pressure 20 bar (2,0 MPa)
 Rated pump flow..... 50 l/min
 With Q-inlet 70 l/min
 *depending on configuration and application

Further data

Spring force for spool control 910 in neutral position:
 110 N (11,0 kp).
 Spring force for spool control 901 with fully selected
 spool: 135 N (13,5 kp).

Recommended contamination level at normal duty: equal
 to or better than 18/14 as per ISO 4406.

Hydraulic fluid viscosity range at continuous operation:
 10-400 mm²/s(cSt). Higher viscosity allowed at start up.

Mineral oil and synthetic oil based on mineral oil are
 recommended.

Max. hydraulic fluid temperature range for continuous
 operation: -15°C - + 80°C.

Spool leakage at 100 bar, 32 cSt and 40°C: < 13 cm³/min.

Weight

Inlet section	Weight kg
I01A	1,8
I06B	1,7
I02C	2,5
I01E	2,3
I02Q	4,5
I06Q	4,5

Outlet section	Weight kg
U01A	1,0
U01B	1,4
U01C	0,7

Working section	Weight kg
S01A	2,4
S01B	2,4
S01H	2,8
S02C	1,9
S10A	2,4

Intermediate section	Weight kg
M01A	1,7
M01B	1,7

Dimensions, spool controls

Type	LA mm	LB mm
910	37	
10	74	
11	83	
13	74	
14	74	
L61	97	
L62	97	
L63	97	
L64	101	
P	103	
EP	103	
HPD	70	70
LE11	95	
M19		41
M29		50
M111		41
M211		50
M2		9

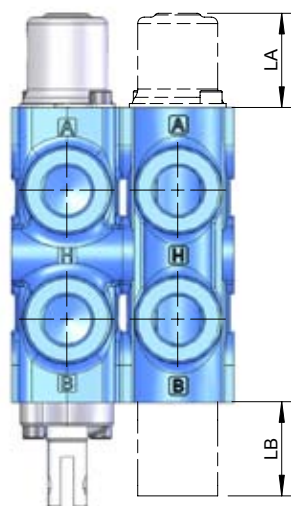



Inlet and outlet type A - side connection

RS 210

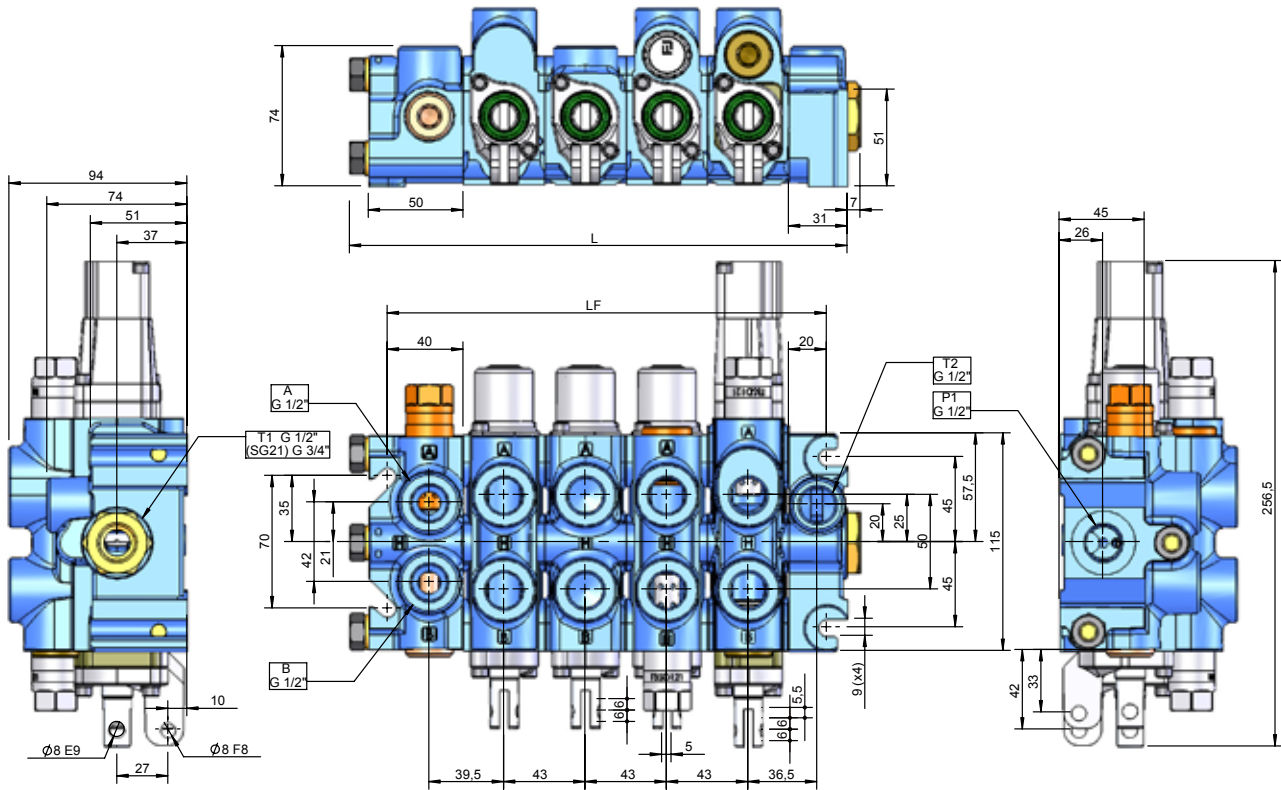

I01A has two pump ports and one tank port.

With the main relief valve fitted in the A-side cavity, the A-port is the pump port and the B-port is the tank port. If the main relief valve is fitted in the B-side cavity the opposite is valid for the pump and tank ports.

With this configuration the max system pressure can be 300 bar.

For information regarding the outlet - see outlet sections.

- 1. Inlet type A I01A
- 2. Main relief valve TBD131
- 3. Plug PL131

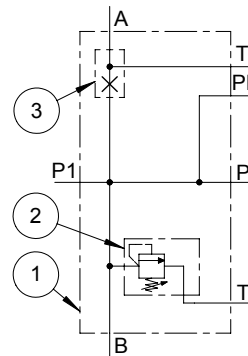

No. of sections	L mm	LF mm
1	136	103
2	179	146
3	222	189
4	265	232
5	308	275
6	351	318
7	394	361
8	437	404

Oil temperature/viscosity for all graphs: + 50°C / 32 cSt

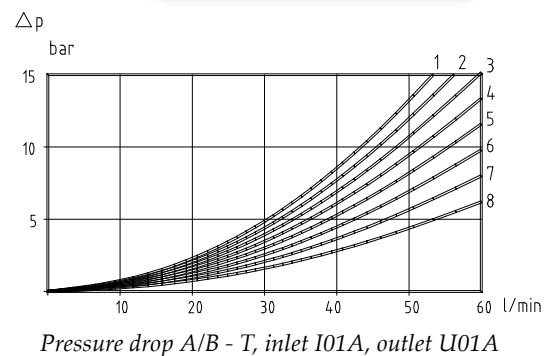
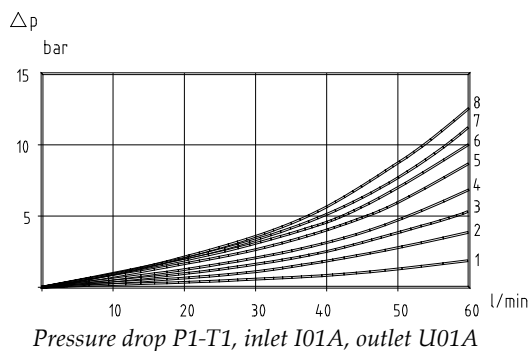

Inlet and outlet section type B - top connection

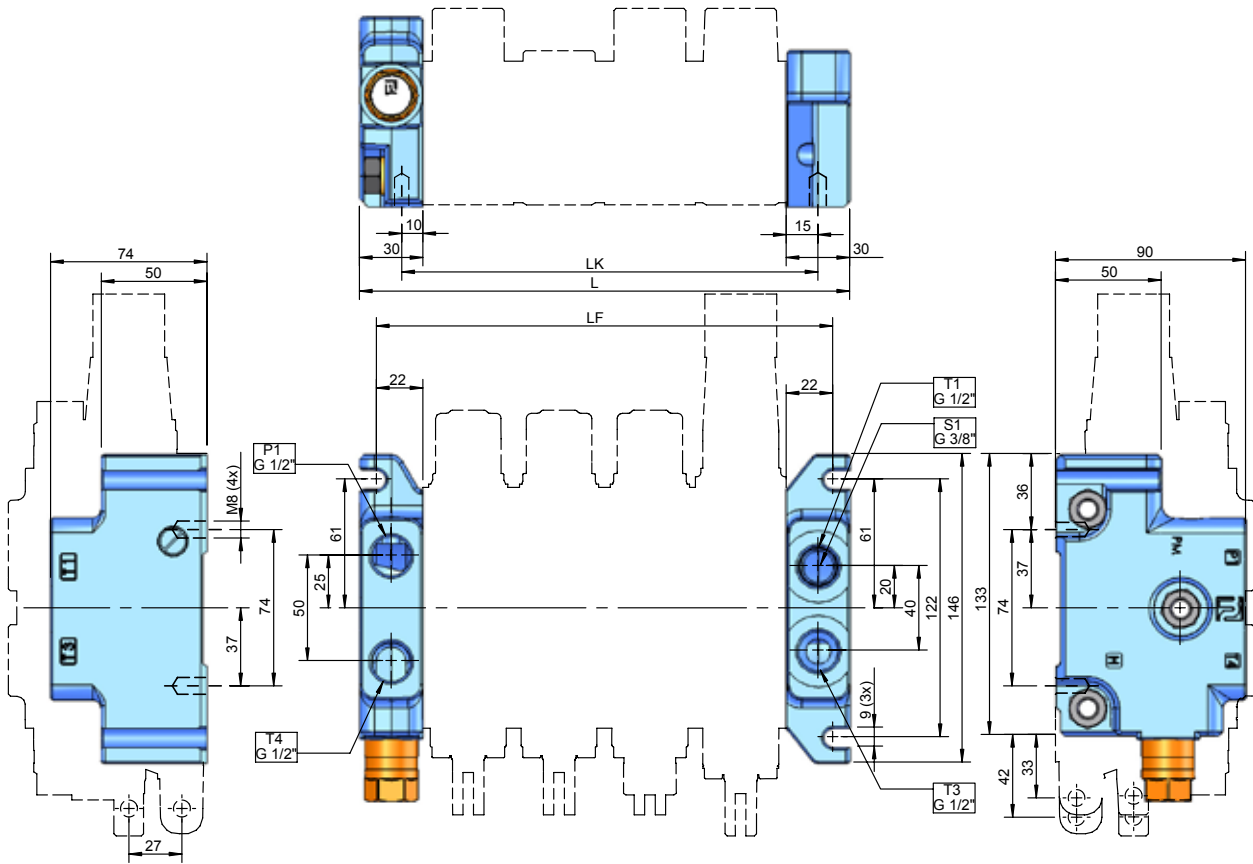

I06B has one pump port and one tank port, both facing upwards. The main relief cavity is on the B-side.

With this configuration the max system pressure can be 300 bar.

Note: Inlet of type B offers a connection between the tank galleries of A and B sides.

For information regarding the outlet - see outlet sections.

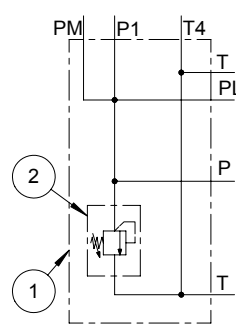

No. of sections	L mm	LF mm	LK mm
1	103	87	68
2	146	130	111
3	189	173	154
4	232	216	197
5	275	259	240
6	318	302	283
7	361	345	326
8	404	388	369

- 1. Inlet type B I06B
- 2. Main relief valve TBD131

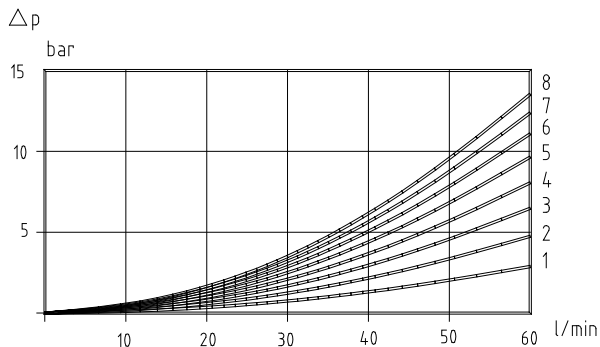

Pressure drop, P1 - T1, inlet I06B, outlet U01B

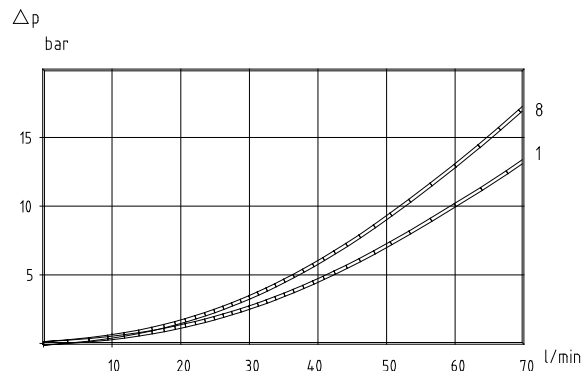

Pressure drop A/B - T, inlet I06B, outlet U01B



Inlet and outlet section type C - end plate

RS 210

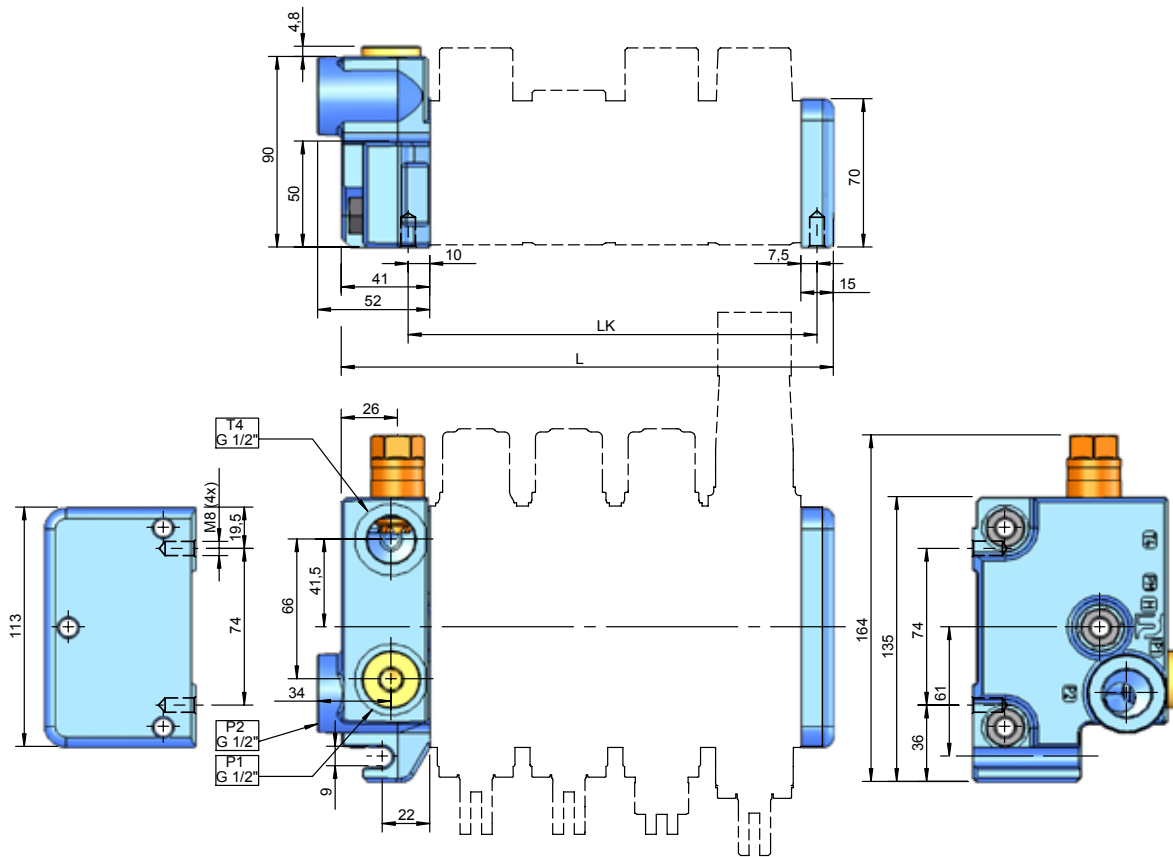

I02C has two pump ports and one tank port. The main relief valve cavity is on the A-side.

Note: Inlet type C offers a connection between tank galleries of A and B sides.

For information regarding the outlet - see outlet sections.

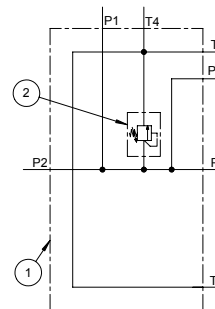

No. of sections	L mm	LK mm
1	98	61
2	141	104
3	184	147
4	227	190
5	270	233
6	313	276
7	356	319
8	399	362

- Inlet type C I02C
- Main relief valve TBD131

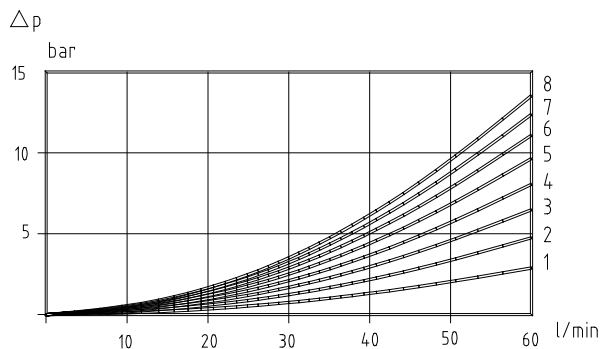

Pressure drop, P1 - T4, inlet i02C, outlet U01C

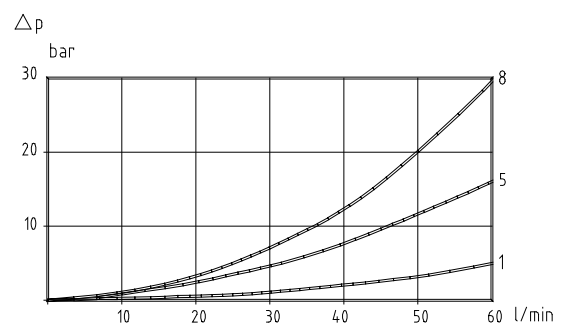

Pressure drop, P1 - T1/T3, inlet I02C, outlet U01B

Inlet type E - with electrical unloading

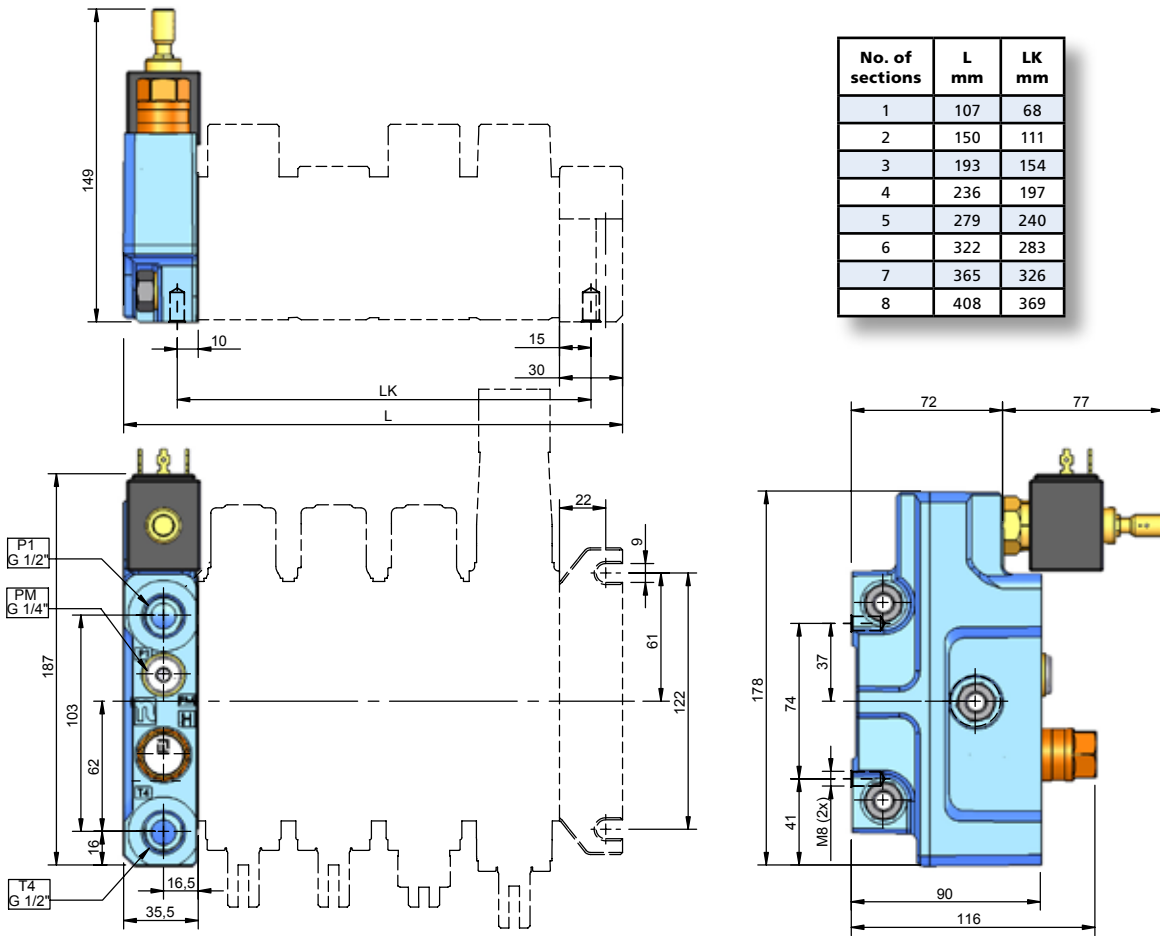

I01E has one pump port and one tank port, both facing upwards. The main relief cavity is facing upwards. Main relief options: TBD160 up to 300 bar and TBS400 up to 350 bar.

The cavity for the electrical unloading valve is facing upwards. The A- and B-side tank channels are connected.

- 1. Inlet type EI01E
- 2. El. unloading valve..... E912
- 2. El. unloading valve..... E926
- 3. Main relief valve TBD160
- 3. Main relief valve TBS400

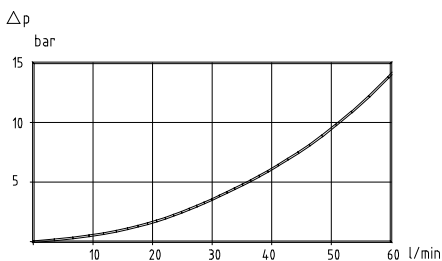
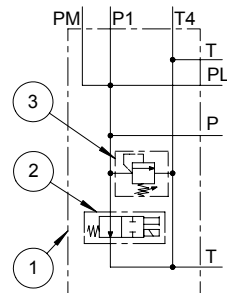

Pressure drop, P1 - T4, inlet I01E, unloaded

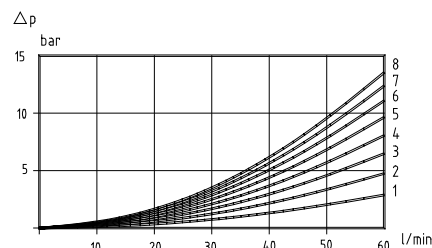

Pressure drop, P1 - T1/T3, inlet I01E, outlet U01B



Inlet type I02Q - with by-pass and electrical unloading

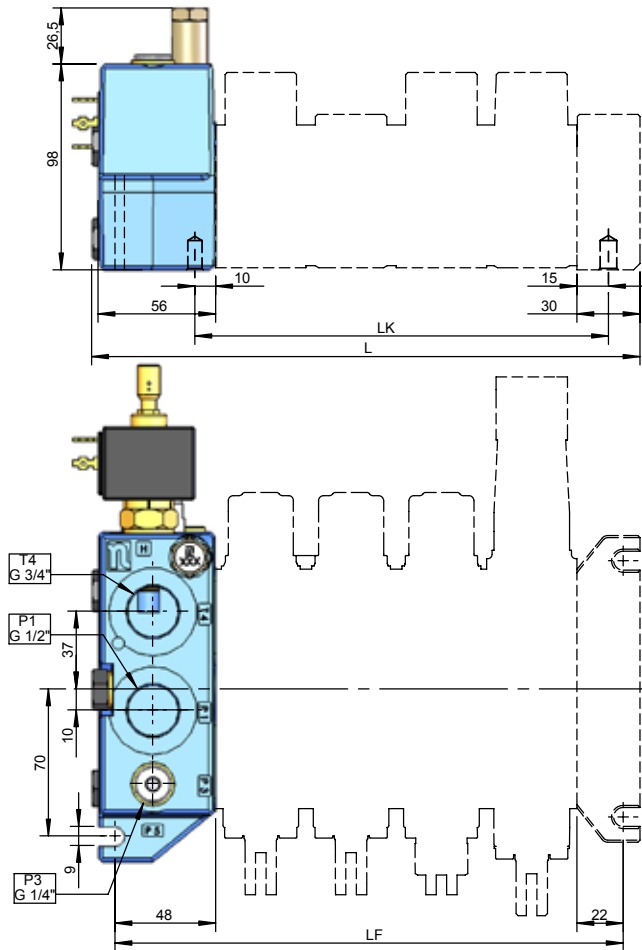

No. of sections	L mm	LF mm	LK mm
1	135	113	68
2	178	156	111
3	221	199	154
4	264	242	197
5	307	285	240
6	350	328	283
7	393	371	326
8	436	414	369

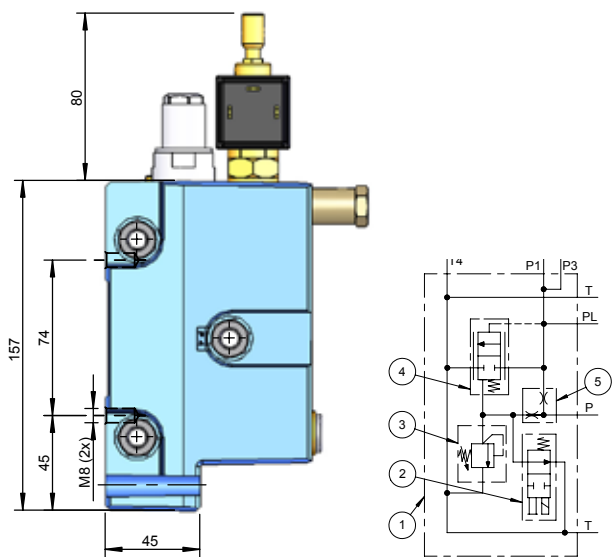

I02Q is an inlet section with flow control, main relief valve and unloading function.

When the system is idling a small regulated flow passes the centre gallery of the valve. Excess pump flow is routed directly to tank.

The regulated flow is defined by the flow control valve FKA283 and the metering orifice PF.

When a spool is operated the whole pump flow is instantly available for the user. The low center gallery flow during idling conditions reduce pressure drop P-T through the valve body, and this facilitates higher pump flow without negative influence on the spool forces and heat generation.

I02Q also is equipped with main relief valve TB12, which together with flow control FKA283, function as a pilot operated main relief valve. Q-inlet can be equipped with a solenoid operated valve for electrical unloading.

The available metering orifices are PF11 and PF12. In combination with FKA283 they provide:

- PF11 25 l/min
- PF12 28 l/min

A lower flow creates less pressure drop P - T.

A spool that matches the flow improves the operating characteristics.

- 1. Inlet type Q I02Q
- 2. El. unloading valve E912
- 2. El. Unloading valve E926
- 3. Main relief valve TB12
- 4. Flow control FKA283/2
- 4. Flow control FKA283/3
- 5. Metering orifice, diam 5,4 mm PF11
- 5. Metering orifice, diam 5,7 mm PF12

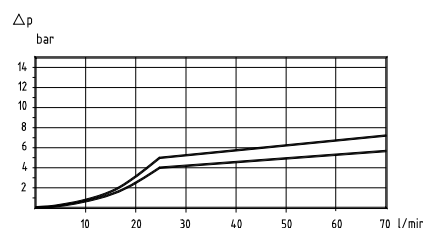

Pressure drop, P1 -T4, inlet I02Q/I06Q, with flow control FKA283/2 and PF12, outlet U01B

Inlet type I06Q - with by-pass and electrical unloading

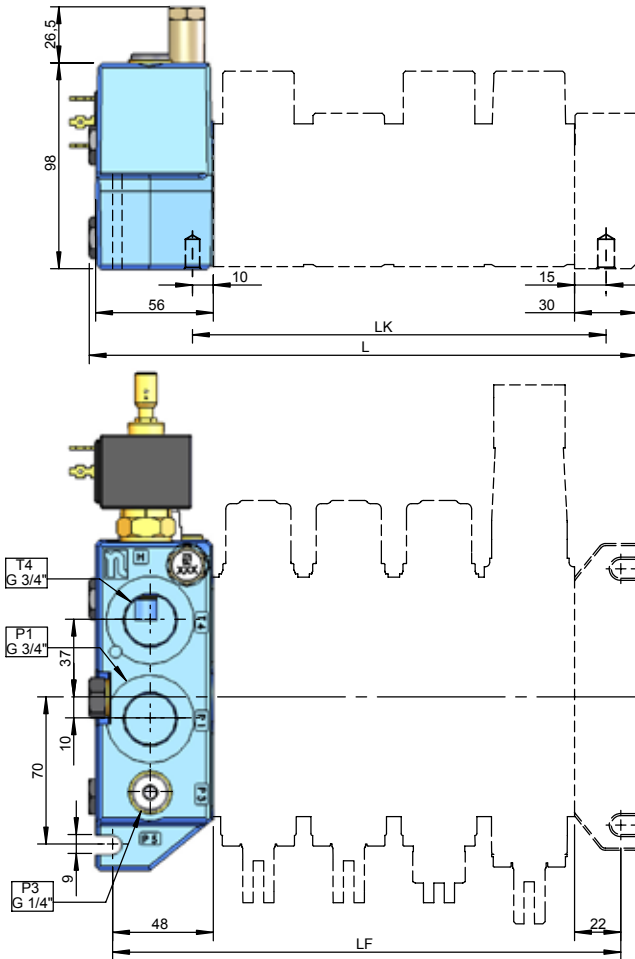

No. of sections	L mm	LF mm	LK mm
1	135	113	68
2	178	156	111
3	221	199	154
4	264	242	197
5	307	285	240
6	350	328	283
7	393	371	326
8	436	414	369

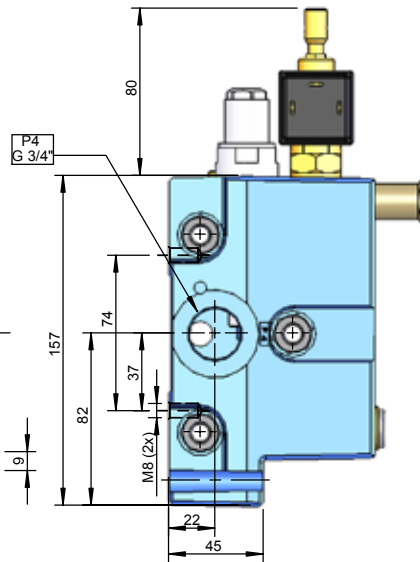

I06Q has the same functions as I02Q but with an added special check valve FSB3 in the signal gallery to damp the unloading function of the flow control valve FKA. I06Q also provides an additional pump port.

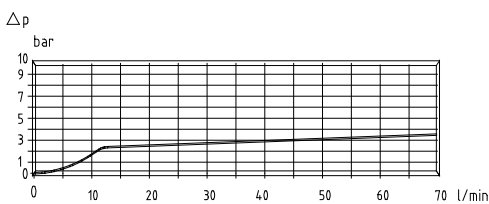
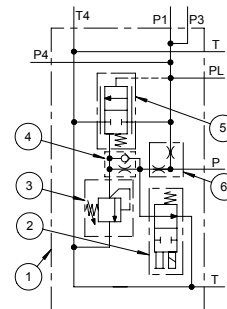

Pressure drop P1 - T4, inlet I02Q/I06Q, unloaded

- 1. Inlet type Q..... I06Q
- 2. El. unloading valve..... E912
- 2. El. Unloading valve E926
- 3. Main relief valve TB12
- 4. Damp check valve..... FSB3
- 5. Flow control FKA283/2
- 5. Flow control FKA283/3
- 6. Metering orifice, Ø 5,4 mm PF11
- 6. Metering orifice, Ø 5,7 mm PF12



Working sections

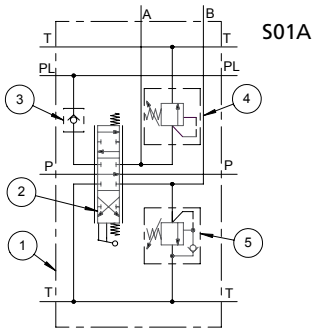

S01A, for 3-position spool and cavities for service port valves

- 1. Spool section S01A
- 2. Spool
- 3. Checkvalve MB01
- 4. Port relief valve TBD121
- 5. Port relief and anticavitation valve TBSD121

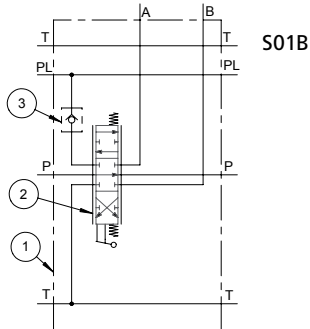

S01B, for 3-position spool without cavities for service port valves

- 1. Spool section S01B
- 2. Spool
- 3. Checkvalve MB01

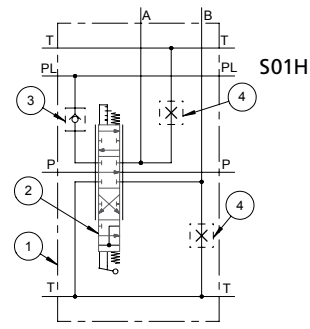

S01H, for 4-position spool and cavities for service port valves

- 1. Spool section S01H
- 2. Spool
- 3. Checkvalve MB03
- 4. Plug P121

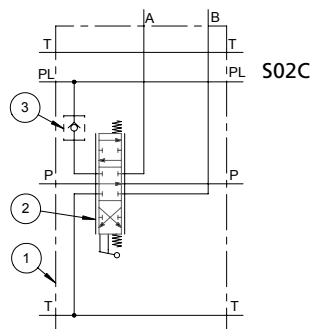

S02C, for 3-position spool without service port valve possibility

- 1. Spool section S02C
- 2. Spool
- 3. Checkvalve MB01

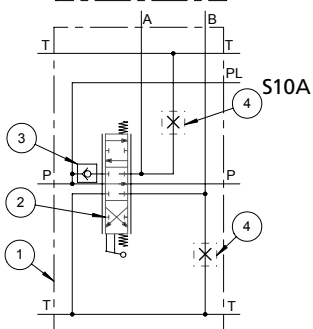

S10A, for 3-position spool and cavities for service port valves for tandem circuits

- 1. Spool section S10A
- 2. Spool
- 3. Checkvalve MB01
- 4. Plug P121

Intermediate sections

M01A is an intermediate inlet section used in dual circuit systems. The A-port is for pump connection and the B-port is for tank connections. The main relief valve cavity is on the A-side. The second circuit pump is connected to port A. If the first circuit pump flow is connected to the inlet section and spool sections upstream of M01A is not used, both pump flows are available for use downstream of M01A. The tank gallery is common for all sections.

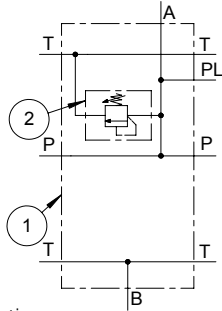

- 1. Intermediate sectionM01A
- 2. Main relief valve TBD131

M01B, is an intermediate inlet section used for two completely separated circuits. The A-port is for pump connection and the B-port is for tank connections. The main relief valve cavity is on the A-side. The tank gallery is common for all sections.

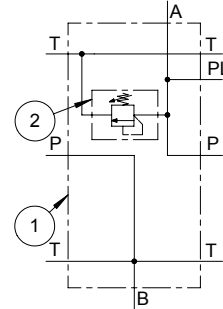

- 1. Intermediate section M01B
- 2. Main relief valve TBD131

Outlet sections

U01A has two tank ports , T2 on the top and T1 on the side. For series connection a high pressure carry-over nipple should be fitted in T1. In this case an alternative tank port always has to be connected to the tank.

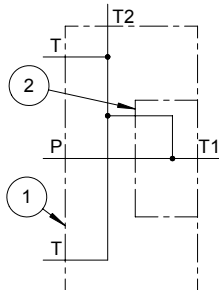

- 1. Outlet section U01A
- 2. High pressure carry over nipple.....SG21

U01B has two tank ports, both facing upwards. For series connection a high pressure carry-over plug PS20 should be fitted in location S1 in port T1. In this case an alternative tank port always has to be connected to the tank.

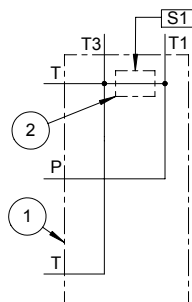

- 1. Outlet section.....U01B
- 2. Plug (S1) PS20

U01C is an end plate without porting.

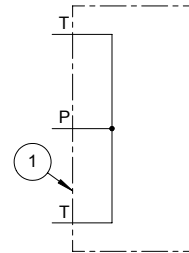

- 1. Outlet section..... U01C

U01A
High pressure carry-over nipple SG21 is fitted in port T1.

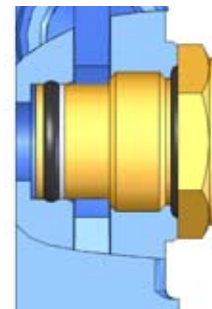

U01B
High pressure carry-over plug PS20 is fitted through port T1 in location S1. T1 is now port for series connection.

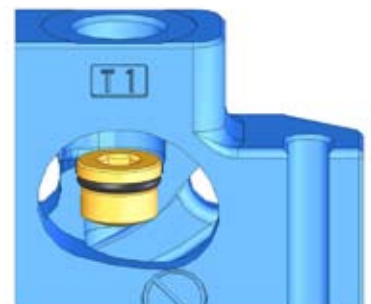



Electrical unloading valve

The electrical unloading valve is a 2-way, normally open, solenoid type cartridge valve. It is an option in inlet sections I02Q, I06Q and I01E.

It is intended for emergency stop and for pressure drop/heat generation reduction.

In Q-inlets a de-energised unloading valve drains the pilot circuit so that the FKA283 spool dumps the whole pump flow directly to tank.

In inlet I01E a de-energised unloading valve dumps the whole pump flow to tank.

Data

Rated flow.....	40 l/min
Power consumption.....	17 W
Rated voltage:	12 or 26 V
Max voltage variation	+/- 10%
Duty factor*	100%
Connection.....	Hirschmann ISO 4400 DIN 43650
Protection class	IP65

* Sufficient cooling must be secured

The unloading valve has manual override.

E912 and E926 has push and twist type pin operation.

This pin is sealable.

PE20 is the plug for the cavity.

Codes

E912	push and twist type override 12 V
E926	push and twist type override 26 V

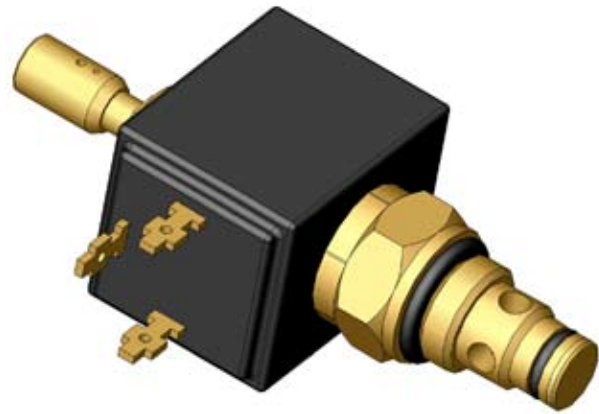

Main relief valves

Main relief valve TBS400

TBS400 is a pilot operated relief valve for the primary circuit. It is adjustable and sealable.

It is optional in inlet section I01E.

Setting range: 35 - 350 bar (3,5 - 35,0 MPa).

Setting range step: 5 bar.

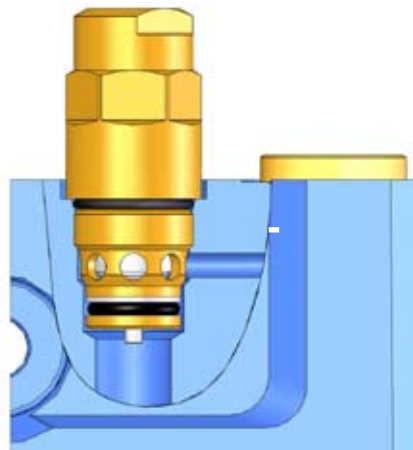
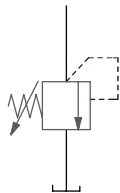
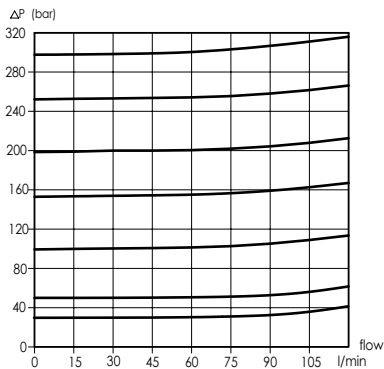

Main relief function with TB12

The flow control valve FKA283, in combination with the relief valve TB12, form the pilot operated main relief function of the Q-inlets. TB12 is adjustable and sealable.

Setting range: 35 - 350 bar (3,5 - 35,0 MPa).

Setting range step: 5 bar.

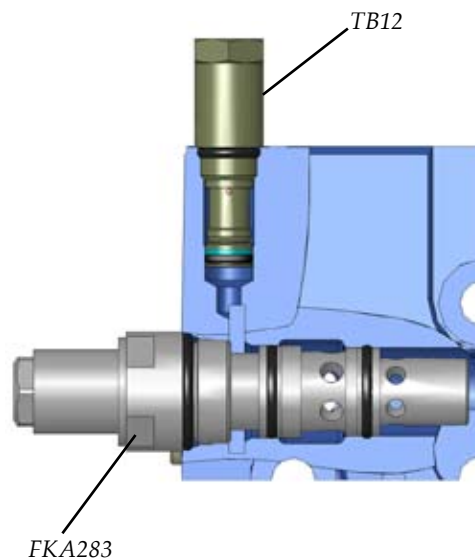
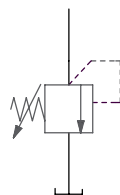
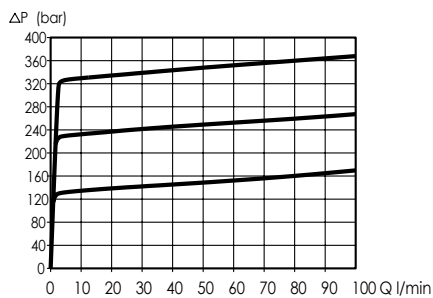



Main relief valves

Main relief valve TBD131

TBD131 is a differential area, direct acting relief valve for the primary circuit. It is adjustable and sealable.

TBD131 is used in inlet sections I01A, I06B, I02C and intermediate sections M01A and M01B.

Setting range: 35 - 300 bar (3,5 - 30,0 MPa).

Setting range step: 5 bar.

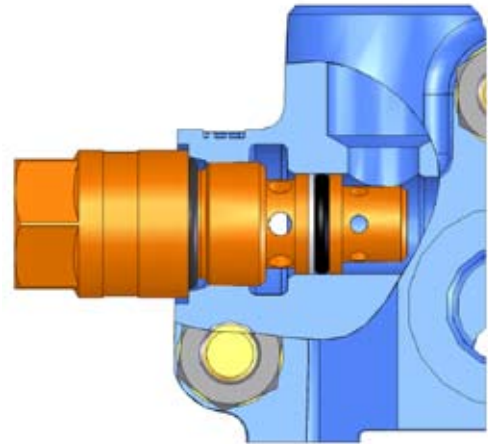

RS 210

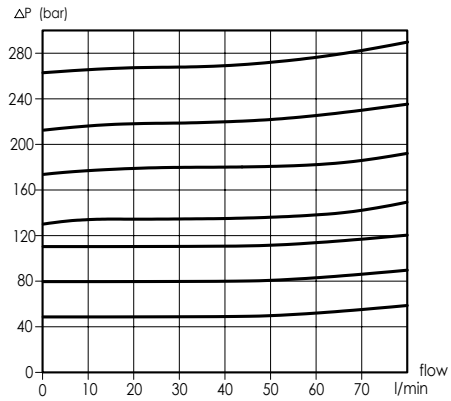
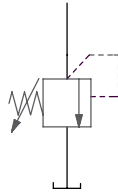

Main relief valve TBD160

TBD160 is a differential area, direct acting relief valve for the primary circuit. It is adjustable and sealable.

TBD160 is optional in inlet I01E.



Setting range: 35 - 300 bar (3,5 - 30,0 MPa).

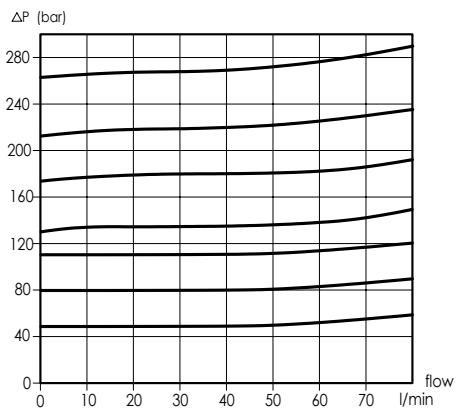
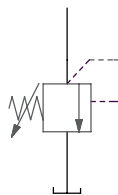
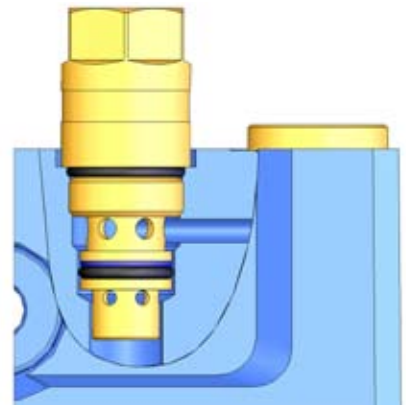

Setting range step: 5 bar.

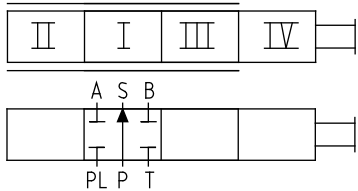
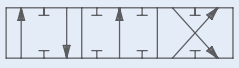
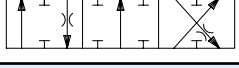
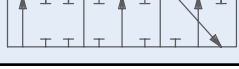
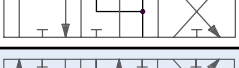
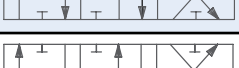

Spools

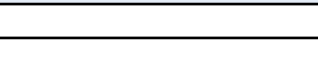
The RM 230 spools are available in variety of flows and styles to accommodate most design requirements. Since the development of spools is a continuous process and all available spools are not described in this data sheet, contact Nordhydraulic for advice on choosing spools in order to optimize your valve configuration.

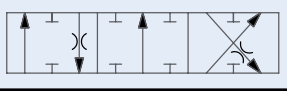
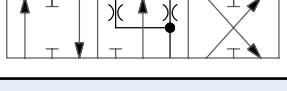
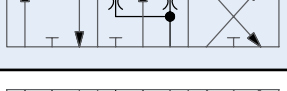
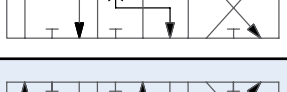
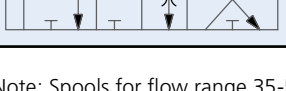
	Spools for general use		
	Function	10 -30	25 - 50
	Double acting spool	1D	1K
	Slewing spool, gentle operating	-	1M
	Single acting spool P - A	2D	2K
	Motor spool	-	4K
	Motor spool A - T	-	4KA
	Motor spool B - T	-	4KB
	Double acting spool with 4th pos. for float	3D	3K

	Spools designed for cranes			
	Function	20-30	30-45	35-50*
	For slewing function. In combination with spool control 918 only.	12SA	14SA	124SA
	For use with load holding valves. Asymmetric. B-port to be connected to piston side of cylinder.	12ZA	14ZA	124ZA
	For use with load holding valves.	12ZB	14ZB	124ZB
	For use with load holding valves. Asymmetric. A-port to be connected to piston side of cylinder.	12XA	14XA	124XA
	For use with load holding valves. Asymmetric. B-port to be connected to piston side of cylinder.	12YA	14YA	124YA

* Note: Spools for flow range 35-50 l/min in combination with Q-inlets only.



Spool controls - A-side

Spool control 9

9 Spring centered.
9W for cable control.

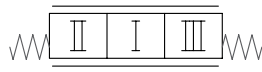

Spool control 10

Detents at positions 1, 2 and 3.



Spool control 11

Spring centering with detent at position 4.



Spool control 13

Spring centering with detent at position 2.



Spool control 14

Spring centering with detent at position 3.

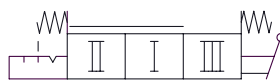

Spool control P

Pneumatic*.



Spool control EP

Electro/pneumatic on/off**.



**

Power consumption.....	4,8 W
Rated voltage	24 V
Max voltage variation	+/- 10%
Duty factor:	100%
Connection	according to EN175301-803/B
Protection class.....	IP65

Spool control HPD

Hydr. proportional. Pilot pressure 6-16 bar. Max pilot pressure 25 bar*.



Spool control L61

External hydraulic kick-out from inserted spool*.



Spool control L62

External hydraulic kick-out from extended spool***.



Spool control L63

External hydraulic kick-out from inserted and extended spool***.



Spool control L64

External hydraulic kick-out from inserted and extended spool, locking neutral position*.



Spool control LE11

Spool position indicator. Operating range 10-30 V. Output voltage, spool centered : < 1V. External electronics are required.



* Connection G 1/8" BSP

*** Connection G 1/4" BSP

Spool controls - B-side

Bracket M19

Bracket for 3-position spool, gear ratio 9:1.

Bracket M29

Bracket for 4-position spool, gear ratio 9:1.

Bracket M111

Bracket for 3-position spool, gear ratio 11:1.

Bracket M211

Bracket for 4-position spool, gear ratio 11:1.

Bracket M2

Bracket for 3-position spool, without ear.

3W

Cap for 3-position spool controlled by cable.

4W

Cap for 4-position spool controlled by cable.

Lever M2K250

Coordinate lever for spools with 3 or 4 position.

Service port valves

Port relief valve TBD121

TBD121 is a differential area, direct acting relief valve for the secondary circuit. It is adjustable and sealable.

Setting range: 35 - 300 bar (3,5 - 30,0 MPa).

Setting range step: 5 bar.

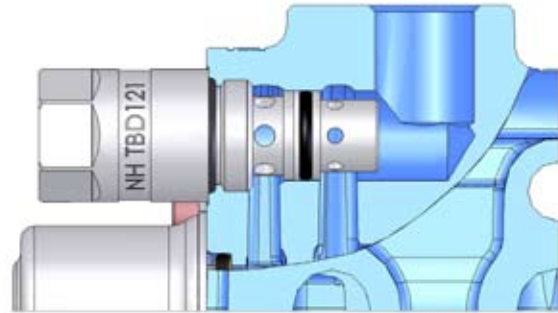
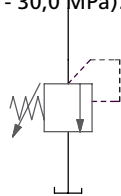

Port relief and anticavitation valve TBSD121

See TBD121 and SB160 for functional principles

Setting range: 35 - 300 bar (3,5 - 30,0 MPa).

Setting range step: 5 bar.

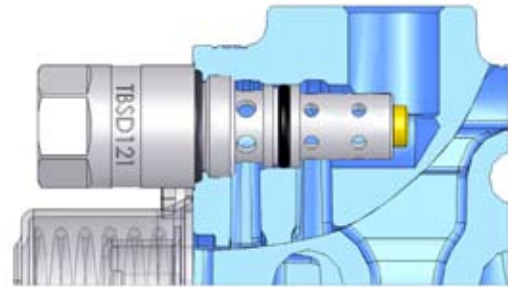
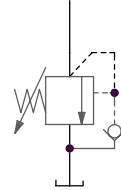

Anticavitation valve SB160

The anticavitation valve service to ensure that, in the event of a lower pressure in the cylinder port than in the tank, oil can be drawn from the system oil tank to the consumer.

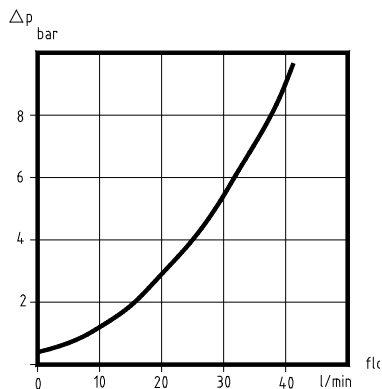
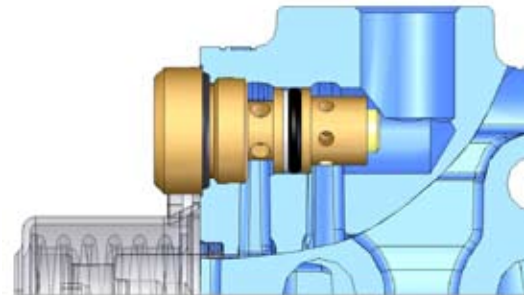

Anticavitation characteristics
TBSD121 and SB160

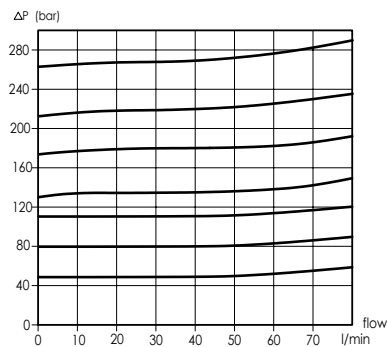

Pressure drop characteristics
TBD/TBSD121



Typical hydraulic circuit diagram

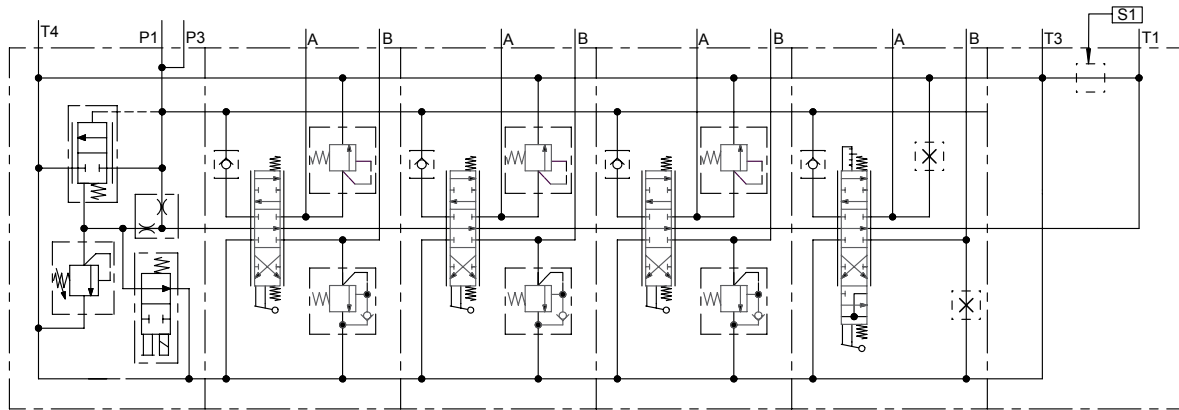

Hydraulic circuit diagram for a four sectional RS 210 valve. It is fitted with a Q-inlet with electrical unloading. The first three sections contain 3-positions spools for double acting functions and port relief and anticavitation valves. The fourth section contains a 4-position spool for double acting functions with float position in position 4. The outlet gives possibility for high pressure carry-over (if S1 is plugged).

RS 210



Solutions that power your visions

RS 210